

Section A-A
1:5

Felt/breather membrane
VELUX underfelt collar BFX
VELUX EKE Front edge

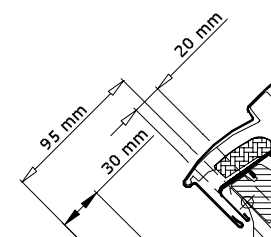
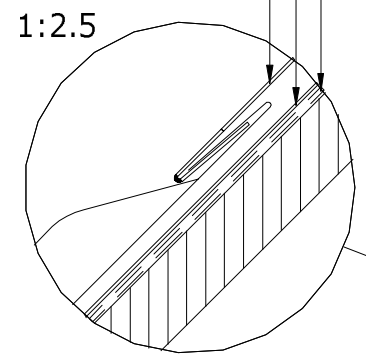

Roofing deck
Inner ventilation

1:2.5
Felt/breather membrane

VELUX VELUX EKE Gutter
VELUX underfelt collar BFX

VELUX EKE Gutter

Section A-A
1:5

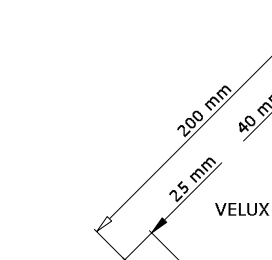

Felt/breather membrane

1:2.5

VELUX Vapour barrier BBX

Section B-B
1:5

VELUX EKE L-shaped side piece insertion
VELUX Underfelt collar BFX

Gasket on BBX in window rebate
VELUX Insulation frame BDX 2000

Felt/breather membrane

Ventilation path

VELUX Lining LS- X15
VELUX Vapour barrier BBX

TRIMMER where necessary

Insulation
Vapour barrier

VELUX Underfelt collar BFX
VELUX EKE middle gutter

100 mm

Red level

20-30 mm

VELUX EKY Support Rafter

VELUX Vapour barrier BBX
VELUX Lining LS- X15
Rafter

VELUX Products:

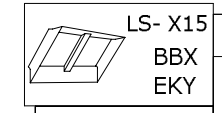
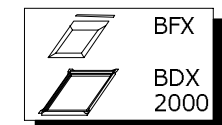
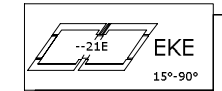

Roof covering:

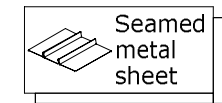

© VELUX GROUP ® VELUX, VELUX logo are registered trademarks



VELUX A/S

Get more
daylight
Get more
comfort
Use less
energy

Note:
When installing VELUX Roof Windows, flashings
and installation products, the manufacturers
instructions and current building and fire
regulations, where applicable, must be met.

VELUX Roof Window GGL+GGL into seamed metal sheet
VELUX insulation collar BDX 2000 incl. felt collar BFX
VELUX flashing EKE --21E and VELUX lining LS- X15
VELUX vapour barrier collar BBX + VELUX EKY

Date	File name	Drawing no.
27.02.2013	EKE-GGL-XXX-0213	-
All measurement in mm		-
SCo		