

Product information

Fixed flat roof window CFP

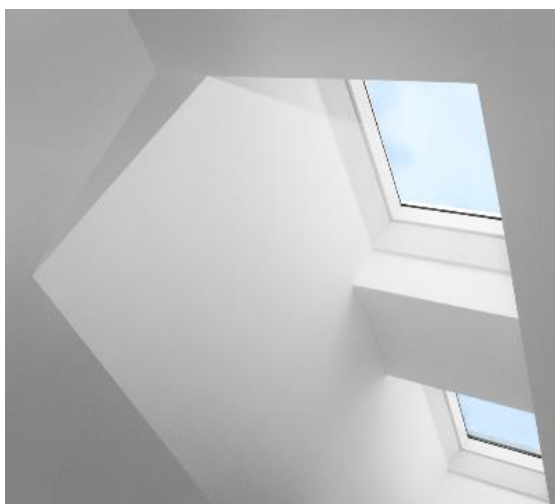

Product description

- Fixed (not opening) window for flat roofs
- Wear-resistant, high quality white PVC frame
- Low energy insulating glass unit
- Protective dome
- Maintenance-free surfaces

Roof pitch

- Can be installed in roof pitches between 0° and 15°

Materials

- Extruded PVC
- Glass, laminated inner pane
- VELUX ThermoTechnology™ insulation
- Acrylic or polycarbonate

Downloads

For installation instructions, CAD drawings, 3D BIM objects, 3D GDL objects etc, please visit velux.co.uk

Certifications



The VELUX product factories guarantee quality systems implementation process and environmental management systems through appropriate accreditations ISO 9001 and ISO 14001

EUTR In compliance with the EU Timber Regulation (EUTR), EU regulation 995/2010

REACH We are aware of the REACH regulation and acknowledge the obligations. No products are obliged to be registered in accordance to REACH and none of our products contain any Substances of Very High Concern.

Available sizes and daylight area

	600 mm	800 mm	900 mm	1000 mm	1200 mm	1500 mm
600 mm	CFP 060060 (0.19)					
800 mm		CFP 080080 (0.40)				
900 mm	CFP 060090 (0.32)		CFP 090090 (0.54)			
1000 mm				CFP 100100 (0.70)		
1200 mm			CFP 090120 (0.76)		CFP 120120 (1.07)	
1500 mm				CFP 100150 (1.11)		CFP 150150 (1.78)

() = Effective daylight area, m²

Lining measurements

Size	W x H mm
060060	559x559
080080	759x759
060090	559x859
090090	859x859
090120	859x1159
100100	959x959
100150	959x1459
120120	1159x1159
150150	1459x1459

External frame measurements

Size	W x H mm
060060	780x780
080080	980x980
060090	780x1080
090090	1080x1080
090120	1080x1380
100100	1180x1180
100150	1180x1680
120120	1380x1380
150150	1680x1680



Flat roof window CFP

- is a fixed (not opening) window – no ventilation possible
- adds daylight to rooms with very little natural light
- features a modern and attractive design
- meets all technical demands

Width

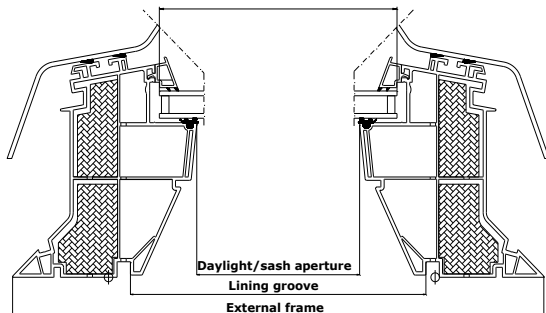

Height

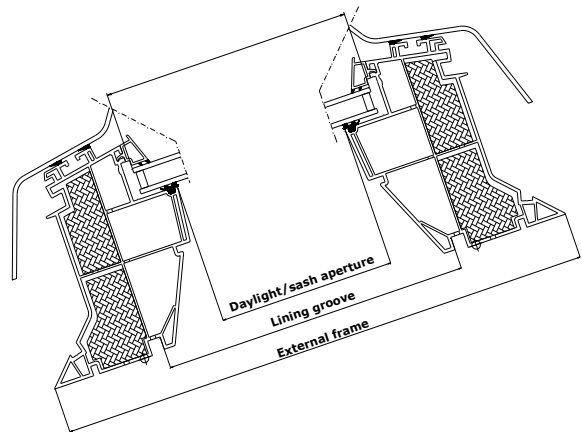

Glazing structure

	--73FQT
Inner glass pane	2 x 3 mm laminated float with low ϵ coating
Outer glass pane	4 mm float with coating
Cavity	14.5 mm
Glass panes	Double
Gas filling	Argon

Visible features



Note! Illustration shows VELUX INTEGRA® flat roof window CVP

1 Dome

- provides significant rain noise reduction and excellent sound insulation
- protects the insulating glass unit
- polycarbonate
- clear or opaque

2 Insulation

- frame filled with polystyrene for superb insulation

3 Frame

- PVC profiles provide a nice, smooth surface
- easy cleaning
- maintenance-free

4 Lining

- unique lining groove makes it easy to build an accurate lining and get a smooth finish

5 Insulating glass unit

- double-glazed
- inner laminated pane for personal safety

6 Dome fittings

- anchors make it easy to fit and secure the dome and to remove it for cleaning

Cleaning and maintenance

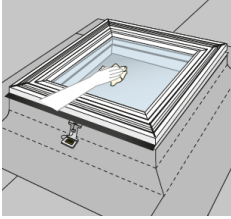

To clean the outer pane of the insulating glass unit, remove the dome from the flat roof window.

Clean the dome, with clean water only. Do not add cleaners/detergents to the water.

Acrylic or polycarbonate dome



Polycarbonate dome:

- extra impact-resistance and fire protection
- useful in some industrial buildings where the windows are installed close to fire breaks - or in places with frequent traffic on the roof
- available in clear and opaque

Blinds and awnings



Interior sun screening

- Blackout blind *
- Pleated blind *



Exterior sun screening

- Awning blind ▲

* Available in mains powered version

▲ Available in solar powered version

The mains and solar powered versions are part of the VELUX INTEGRA® product range.

Interior finish

White PVC profiles	NCS standard colour: S 0500-N, Nearest RAL standard colour: 9016
---------------------------	---

Accessories

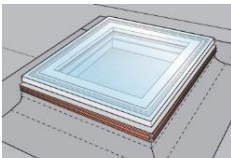

Securing kit ZZZ 210 ensures a safe joint between frame and roofing material



Frame extension with flange ZCE 0015 makes installation in warm or sedum roof constructions possible – extends frame height from 150 mm to 310 mm

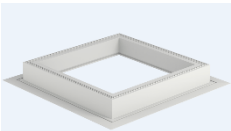

Extra frame extension ZCE 1015 can be combined with frame extension with flange ZCE 0015 when frame height exceeding 310 mm is required

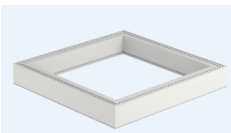

One ZCE 0015 can be combined with max three ZCE 1015

Control options

Control system
KUX 110

For operation of mains powered sunscreening products

Note

We reserve the right to make technical changes.

For more information on flat roof window CFP and other VELUX products, please visit velux.co.uk