

Product information

Roof balcony CABRIO® GDL



Product description

- High quality natural pinewood coated with impregnation and layers of water-based acrylic white paint or clear lacquer
- Top-hung upper section with bottom handle for convenient operation
- Bottom-hung lower section with handles on top sash - opens outwards
- Banister railings and balusters
- Triple glazing
- Ventilation flap and integrated dust and insect filter
- Maintenance-free exterior covers

Roof pitch

- Can be installed in roof pitches between 35° and 53°

Materials

- Laminated pinewood
- Glass, toughened outer glass / laminated inner glass
- Lacquered aluminium, copper or zinc
- VELUX ThermoTechnology™ insulation

Downloads

For installation instructions, CAD drawings, 3D BIM objects, SketchUp objects etc, please visit www.velux.co.uk

Certifications



The VELUX product factories guarantee quality systems implementation process and environmental management systems through appropriate accreditations ISO 9001 and ISO 14001

EUTR In compliance with the EU Timber Regulation (EUTR), EU regulation 995/2010

REACH We are aware of the REACH regulation and acknowledge the obligations. No products are obliged to be registered in accordance to REACH and none of our products contain any Substances of Very High Concern.

Available sizes and daylight area

	472 mm	550 mm	660 mm	780 mm	942 mm	1140 mm	1340 mm
1600 mm					Upper section PK10	Upper section SK10	
					(1.07)	(1.35)	
920 mm					Lower section PK34	Lower section SK34	
					(0.56)	(0.70)	

() = Effective daylight area, m²

Lining measurements

Size	Width (mm)
PK--	887
SK--	1085

Size	Height (mm)
--19	2461

CABRIO® GDL total height

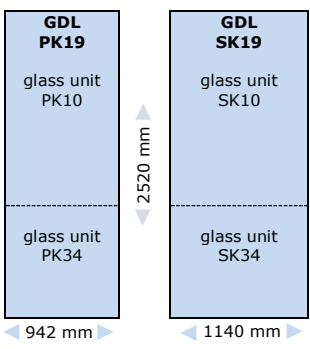

- Roof balcony CABRIO® GDL
- opens into an instant balcony in seconds
 - offers direct access to the outside
 - adds fresh air, daylight and a great view

The top-hung upper section is bottom-operated and remains open in all positions up to 45°
 The bottom-hung lower section is opened/closed with two handles on the top sash. Integral banister railings automatically slide into position when the balcony is opened

Width

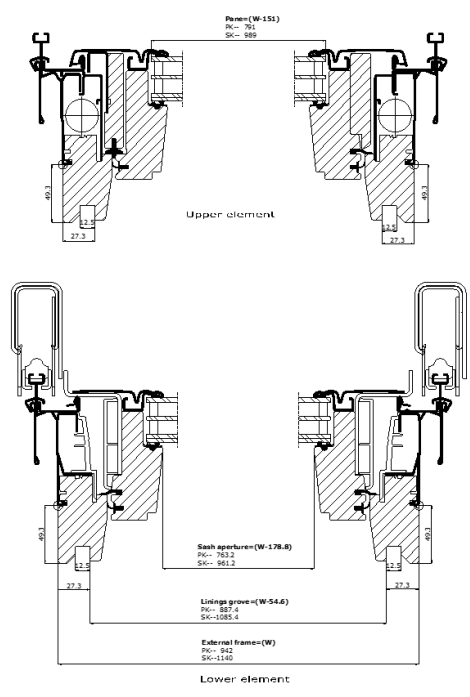

Height

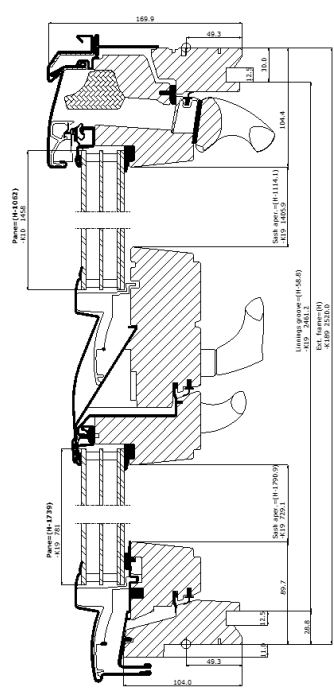

Technical values

	--66	--66L
U_w [W/m²K]	1.2	1.2
U_g [W/m²K]	0.5	0.7
R_w [dB]	37*	34
g []	0.52	0.55
τ_v []	0.71	0.71
τ_{uv} []	0.05	0.05
Air permeability [class]	3	3

Thermal improvements such as lower U-value (U_w) and lower linear heat loss coefficient (φ) can be obtained with frame insulation collar and/or recessed installation.

* R_w value 37 dB applies to GDL PK19 only. For information about R_w value for SK19, please contact www.velux.co.uk

Glazing structure

	--66	--66L
Inner glass pane	2 x 3 mm laminated float with low ε coating	2 x 2 mm laminated float with low ε coating
Middle glass pane	3 mm heat strengthened float with low ε coating	2.2 mm heat strengthened float with low ε coating
Outer glass pane	4 mm toughened with coatings	3 mm toughened with coatings
Cavity	2 x 12 mm	2 x 14 mm
Glass panes	Triple	Triple
Gas filling	Krypton	Krypton

Glazing features

		--66
	Heat insulation Low energy glazing provides reduced heat loss through the window and enhanced indoor comfort.	●●●
	Solar gain In the wintertime, the heat from the sun entering through the windows is a usable solar gain.	●●
	Solar protection In warm climates and in rooms with large window areas, a sun protective coating provides a better indoor climate during summer periods. Alternatively, exterior sunscreening can be installed.	
	Sound insulation A combination of laminated glass and optimal glass thickness provides better sound insulation. Frame/sash construction and gaskets are equally important.	●●●
	Security Thicker laminated inner glass pane designed to increase resistance to manual attack (burglary).	●
	Energy balance The energy balance represents the ability of the roof window to utilise the passive solar gain and keep in the heat during winter and its ability to protect against the risk of overheating during summer. Sunscreening products can further improve indoor summer comfort.	✓
	Safety Laminated inner glass is designed to hold the fragments together if the glass breaks. We recommend that you consider using glass units with laminated glass on the inside for windows placed above areas where people sleep, play or work.	✓
	Outside strength Toughened outer glass pane makes your glazing more resistant to hail, heavy wind and snow loads.	✓
	Delayed fading of materials Inner laminated glass protects materials behind the glass against UV radiation and therefore delays fading of the materials.	✓
	Rain noise reduction The combination of laminated glass and extra thick glass helps provide a significant, audible reduction of rainfall sound. Frame/sash construction and gaskets are equally important.	✓
	Easy-to-clean The easy-to-clean coating minimises the cleaning frequency of the outer glass pane and gives you a clearer view in case of rain.	✓
	Anti-dew The anti-dew coating significantly reduces the days with dew on the outer glass pane and thus gives you a clear view.	✓

● Good ●● Better ●●● Best ✓ Feature included in glazing variant

Technical values, ventilation through ventilation flap

Property	Windows with triple glazing	
	Width	
	PK--	SK--
Air flow characteristics [l/s]	1.7	2.1
Air flow exponent [-]	0.63	0.63
Ventilation capacity at 4 Pa [l/s]	4.1	4.9
Ventilation capacity at 8 Pa [l/s]	6.3	7.6
Ventilation capacity at 10 Pa [l/s]	7.3	8.2
Ventilation capacity at 20 Pa [l/s]	8.1	9.8
Equivalent area through ventilation flap [mm ²]	4600	5600
Geometrical free area [mm ²]	6100	7200

Visible features

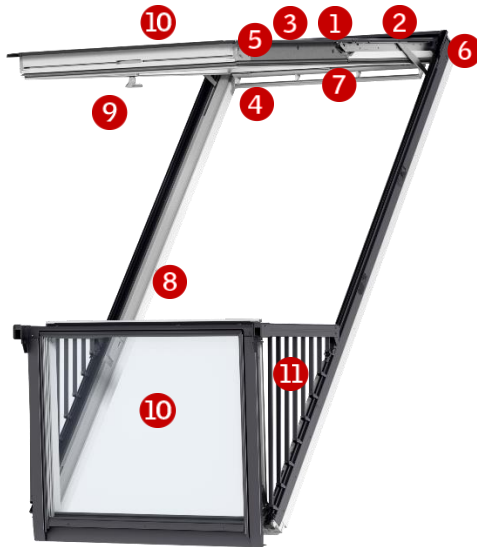

1 Lock casing

- electro-galvanised steel
- colour: "silver"



2 Data plate

- window type, size and variant code
- CE marking
- production code
- QR code

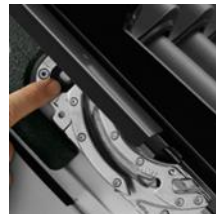

3 Click-on covers

- lacquered aluminium



4 Control bar

- anodised aluminium



5 Excellent insulation

- expanded polystyrene
- colour: grey charcoal



6 Barrel bolts

- plastic
- colour: grey
- steel
- colour: "silver"



7 Hinges with friction

- electro-galvanised steel
- colour: "silver"



8 Barrel bolt bushings

- plastic
- colour: white/grey



9 Bottom handle

- anodised aluminium

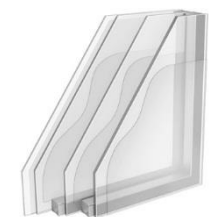

10 Triple glazing

- toughened outer glass
- laminated inner glass for personal safety



11 Railings and balusters

- plastic and painted aluminium
- colour: black
- passivated steel hinges
- colour: "silver"

Cleaning and maintenance



To clean the outer pane from the inside, rotate sash and secure in cleaning position with barrel bolt. Open the upper section to clean the outer pane of the lower element.



VELUX repair and maintenance kits are available.

Exterior covers

Material	NCS standard colour	RAL nearest standard colour
Lacquered aluminium (-0--) grey	S 7500-N	7043
Copper (-1--)	-	-
Titanium zinc (-3--)	-	-

Special colour requests, please contact enquiries@velux.co.uk

Interior finish

White paint	Impregnation and layers of water-based acrylic lacquer and paint, NCS standard colour: S 0500-N, nearest RAL standard colour: 9003.
Clear lacquer	Impregnation and layers of water-based acrylic lacquer

Special colour requests, please contact enquiries@velux.co.uk

Flashings and installation products



Flashings:

- ED- -K19 for single installation
- EK- -K10 / ET- -K34 --00 / ET- -K34 --00- for combi installation

Available for standard installation

Installation products:

- Installation set BDX 2000 (incl BFX) + extension pieces BDX W34 (incl BFX)
- Underfelt collar BFX 1000 incl transverse drainage gutter
- Vapour barrier collar BBX 0000 + extension pieces BBX WK34
- Linings LS- (incl BBX) + additional lining parts LL- (incl BBX)

Note

We reserve the right to make technical changes.

For more information on roof balcony CABRIO® GDL and other VELUX products, please visit www.velux.co.uk

Blinds, awnings and shutters

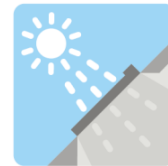

Interior suncreening

- • • Blackout blind
- • • Roller blind
- • • Pleated blind
- • • Flying pleated blind
- • • Double pleated energy blind
- • • Venetian blind
- • • Duo blackout blind

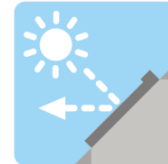

Exterior suncreening

- • • Awning blind
- • • Roller shutter



Additional accessories

- • • Insect roller screen

- • • Available in manual and mains/solar powered versions
- • Available in manual and mains powered versions
- Available in manual version

The mains and solar powered versions are part of the VELUX INTEGRA® product range.